



Kontinental Kitchen Supplies

Unit 85, Cherry Orchard Industrial  
Estate, Dublin 10, D10 DH39  
Tel: 01 6262314  
Fax: 016262416  
sales@kks.ie  
www.kks.ie  
GPS: 53° 20' 42" N, 6° 22' 42" W

NEFF, a division of  
BSH Home Appliances  
Limited  
Home of Innovation  
Showroom  
M50 Business Park  
Ballymount Road Upper  
Dublin 12  
D12 KP90  
Ireland



**NEFF**  
cook. create. inspire.



*For cookaholics  
with character*

THE NEFF CORE RANGE.



*Refreshed. Refined*  
**REDESIGNED**



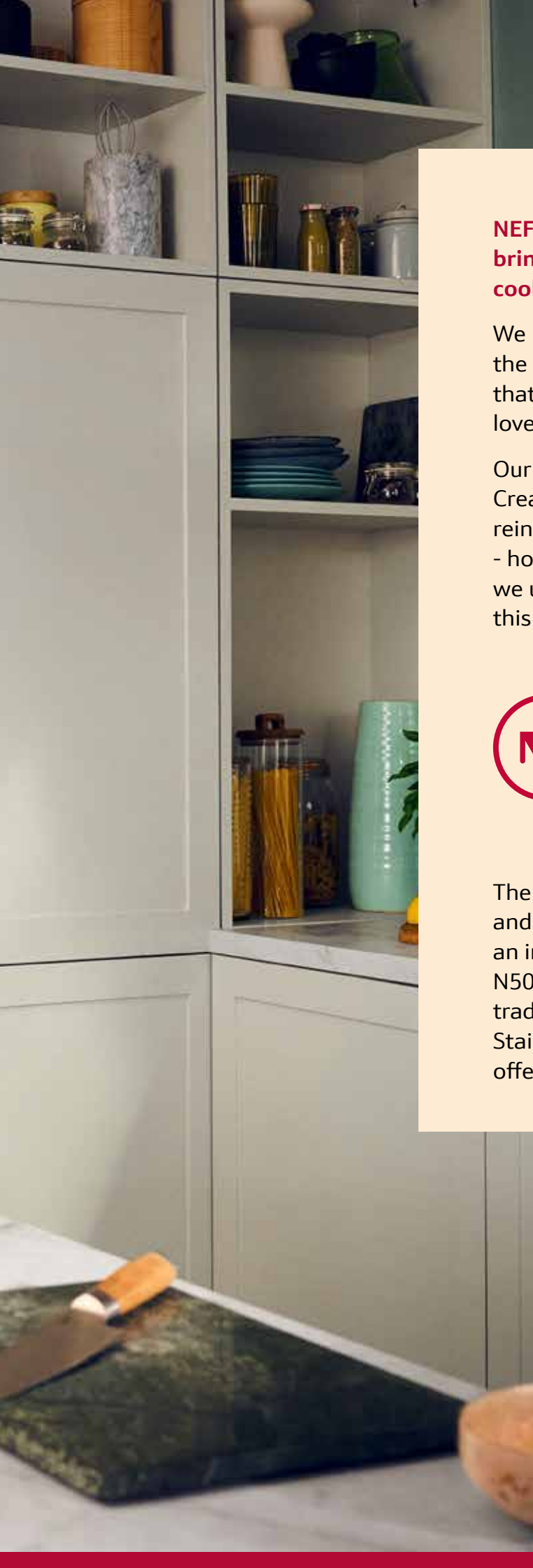

**NEFF has been and always will be about bringing joy to the kitchen and sparking cooking enthusiasm in people.**

We have sharpened, refocused and refined the NEFF brand whilst retaining the values that make NEFF so inspiring to those that love to cook.

Our logo and tagline have evolved - Cook. Create. Inspire. In this concise brochure we reinforce the unconventionality of the brand - how we truly are *Open Like No Other* and we unfold the range that we will introduce this year.



The new refreshed N90 & N70 are refined and sleek in the new Graphite Grey and have an intuitive new Touch Screen Control. Our N50 Range is also fully detailed with the more traditional dial controls available in classic Stainless Steel and Graphite Grey – truly offering something for every cooking style.





# NEFF

## *Open like no other*

**Cooking is an expression** - it's about creating meals using ordinary ingredients but cooking them well - cooking them your way - adding a twist here and there and then sharing that meal. NEFF allows you to cook just how you want - with our range of ovens and technologies we allow you to be creative, be spontaneous, add a twist, a new flavour and remain open to try new things.



## *Open for CREATIVE FREEDOM*

Slide & Hide® –  
The only oven with a  
disappearing door

**Slide & Hide® is simply the first choice for individualists, who want to enjoy their passion for cooking without limitations.**

Our iconic Slide & Hide® door effortlessly slides away beneath the oven when not in use. So nothing gets in the way of your creativity. Get up close and personal to season and stir your favourite dishes.





# *Open for YOUR TASTE*

## Circo Therm® – Hot air system for simultaneous cooking

Circo Therm® hot air technology focuses heat directly on the food being cooked, so surfaces of bakes and roasts are sealed quickly. This seals in moisture, making meats juicier and cakes delicious and moist.

Circo Therm® allows you to be the most creative cook you choose to be - show off bakes evenly cooked, inspiring powerful flavours that can all be cooked with more delicate dishes and each one tastes just as it should - and for those that want to use every inch of the oven when it's on, you can easily bake and roast meals for later in the week at the same time - being not only creative but energy efficient too.





*Dark. Dramatic.  
Contemporary*



# *Introducing* **GRAPHITE GREY** *to the N90 & N70 Collections*

## *Introducing Graphite Grey to our NEFF Core Range*

This rich dark tone of grey will be introduced across the NEFF Core Range throughout 2023. It's already available in our N50 Collection and this brochure has been designed to introduce the brand new features that we are introducing to our N90 & N70 Collections.



## **NEW Twist Pad®**

On selected models there is a brand new Twist Pad®\*. Using the same control to point and twist to operate the hob, this also features a graphite grey trim to accessorize to the oven trim.

\*This new Twist Pad® is available on selected N90 Flex induction hobs.





# *Fascia Display Types* **HIERARCHY**

New high resolution interface available  
across N90 and N70 collections

Our Update to N90 & N70 includes the brand new Full Touch Screen interface. The Full Touch Screen is both intuitive and responsive – control the function and temperature with a swipe and a tap to allow for ultimate flexibility while cooking. The Full Touch Screen is available in three sizes to match the collections.



## N90 Full Touch 3

Full Touch Screen display; 6.8" high resolution TFT colour graphics display.

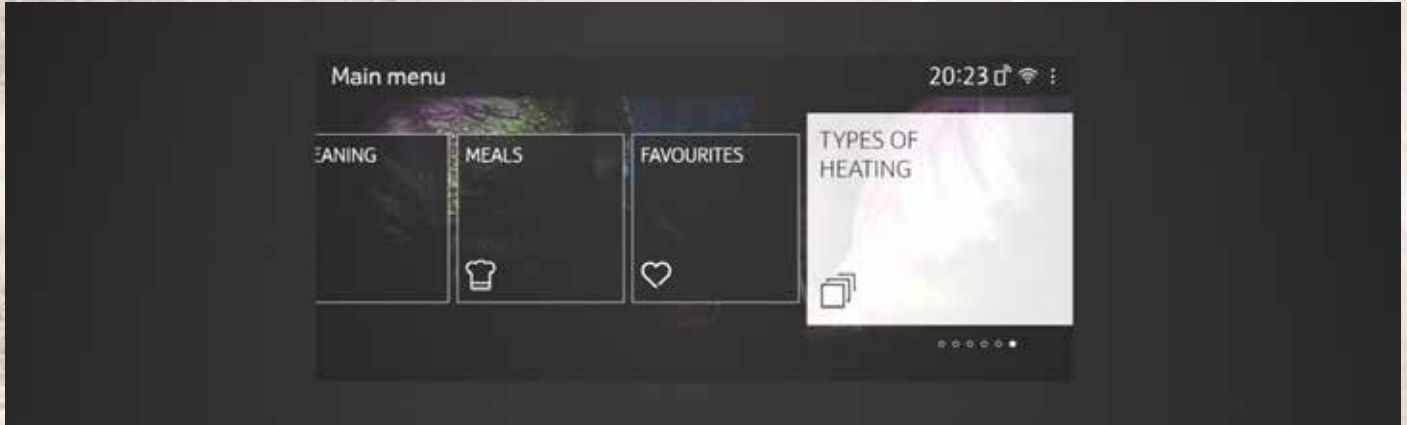

## N90 Full Touch 2

Full Touch Screen display; 4.1" high resolution TFT colour graphics display.



## N70 Full Touch 1

Full Touch Screen display; 3.7" high resolution TFT colour graphics display.







# Fully connected cooking



## NEW Get more with Home Connect

Be inspired and reduce food waste with free recipes in the Home Connect app and with our recipe partners. Achieving perfect results has never been easier. With Oven Assistant, simply use the Home Connect app or ask Alexa to find the perfect setting for your dish. For regularly used programmes, save these as favourites for super quick, convenient access, so you can concentrate on your cooking. Stay better connected with your guests with oven control and monitoring via smartphone, voice or smartwatch. No more dashing back and forth to the kitchen!

\*Home Connect available on selected models only.

## Pyrolytic Self-Cleaning – So you don't have to

With Pyrolytic Self-Cleaning hand cleaning the oven becomes a thing of the past. Turn on the function and let it transform all the splatterings and drippings into ash. When the oven has cooled, wipe off the rest and presto, your oven is spick and span again. Easy Clean comes in handy as a quick way to clean your oven interior in between pyro cycles. Just some water and a drop of liquid detergent, activate the Easy Clean programme and wipe off the softened food residue afterwards.



# NEW N90 and N70 Oven Range – Launching 2023









All single ovens have:

- Circo Therm®



All compact ovens have:

- Soft Open / Close door

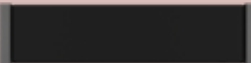
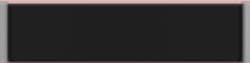
DISPLAY TYPE	SLIDE & HIDE® SINGLE OVENS - WITH ROTATING HANDLE AND SOFT/OPEN CLOSE		COMPACT OVENS
			WITH MICROWAVE
 <p>FULL TOUCH 2 - 4.1" FULL TOUCH TFT DISPLAY N90</p>	 <p><b>B64CS71G0B</b></p> <ul style="list-style-type: none"> <li>• 14 Functions</li> <li>• Pyrolytic</li> </ul>	 <p><b>B64VS71G0B</b></p> <ul style="list-style-type: none"> <li>• varioSteam</li> <li>• 14 Functions</li> <li>• Pyrolytic</li> </ul>	 <p><b>C24MS31G0B</b></p> <ul style="list-style-type: none"> <li>• 20 Functions</li> <li>• ecoClean</li> </ul>
 <p>FULL TOUCH 1 – N70 3.7" FULL TOUCH TFT DISPLAY</p>	 <p><b>GRAPHITE GREY: B54CR71G0B</b></p> <ul style="list-style-type: none"> <li>• 14 Functions</li> <li>• Pyrolytic</li> </ul>	 <p><b>STAINLESS STEEL B54CR71N0B</b></p> <ul style="list-style-type: none"> <li>• 14 Functions</li> <li>• Pyrolytic</li> </ul>	 <p><b>GRAPHITE GREY: C24MR21G0B</b></p> <p><b>STAINLESS STEEL: C24MR21N0B</b></p> <ul style="list-style-type: none"> <li>• 20 Functions</li> <li>• Electronic, 3.7" Full Touch TFT Display</li> <li>• ecoClean</li> </ul>
DISPLAY TYPE	WARMING DRAWER		WARMING DRAWER
<p>All drawers have:</p> <ul style="list-style-type: none"> <li>• Push / Pull opening</li> <li>• 6 temperature settings (excludes Accessory Drawer)</li> <li>- Timer</li> <li>- Heated ceramic base</li> </ul>	 <p><b>GRAPHITE GREY: N24HA11G1B</b></p>	 <p><b>STAINLESS STEEL: N24HA11N1B</b></p>	



# Your Guide To Hobs



## Rethink cooking in NEFF's infinite kitchen

A great meal is all about the ingredients and cooking process. And it's the same when it comes to choosing the right hob. If you want flexibility, an electric FlexInduction hob might be what you're after. Or pick one of our innovative gas or fast induction hobs. Can't decide which one? Then the Domino range might be the best hob for you, as it mixes all of the above. There's a NEFF hob for anyone to get creative with.

## Flex Induction Hobs

For sociable cooks who often find themselves juggling multiple pans, a FlexInduction hob provides any size pan, anywhere cooking within the zones. When the zones are activated, pans will receive instant, even and rapid heat transference wherever they are placed.



Featured model:  
T58FT20X0 N70 Flex Induction Hob

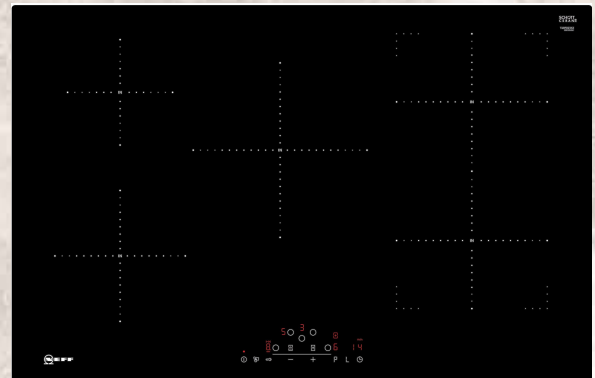

## Induction Hob

If sleek, stylish and clean lines are more in keeping with your kitchen design, our Induction hobs provide a minimalistic and premium look whilst providing a quick and responsive cooking surface. Cooking with an Induction Hob saves energy and is incredibly safe – there is little residual heat once the saucepan is removed from the hob.



Featured model:  
T48FD23X2 N70 Induction Hob

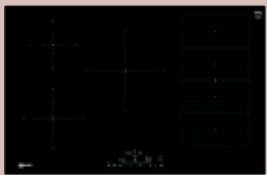

VENTING HOB	FLEX INDUCTION HOBS		INDUCTION HOB
80CM	80CM	60CM	80CM
 <p><b>T48CB1AX2</b></p> <ul style="list-style-type: none"> <li>• Black glass</li> <li>• Venting Hob</li> <li>• Touch Control</li> <li>• 4 x Individual Zones + Ventilation               <ul style="list-style-type: none"> <li>• Auto-On fan</li> <li>• 7.4kW</li> </ul> </li> <li>• Includes 4 Clean air filters a telescopic slider, and an adhesive seal for un-ducted installation.</li> </ul>	 <p><b>T58FD20X0</b></p> <ul style="list-style-type: none"> <li>• Flex Induction Hob</li> <li>• Touch Control</li> <li>• 1xFlex + 3 zones</li> <li>• Front Bevel               <ul style="list-style-type: none"> <li>• 7.4kW</li> </ul> </li> </ul>	 <p><b>T56FD50X0</b></p> <ul style="list-style-type: none"> <li>• Flex Induction Hob</li> <li>• Touch Control</li> <li>• 1xFlex + 2 zones</li> <li>• Front Bevel               <ul style="list-style-type: none"> <li>• 7.4kW</li> </ul> </li> </ul>	 <p><b>T48FD23X2</b></p> <ul style="list-style-type: none"> <li>• Induction Hob</li> <li>• Touch Control</li> <li>• CombiZone, 5 zones               <ul style="list-style-type: none"> <li>• Front Bevel</li> <li>• 7.4kW</li> </ul> </li> </ul>

Venting Hobs Installation Options and Accessories' featured on page 15



# Flex Induction Hobs

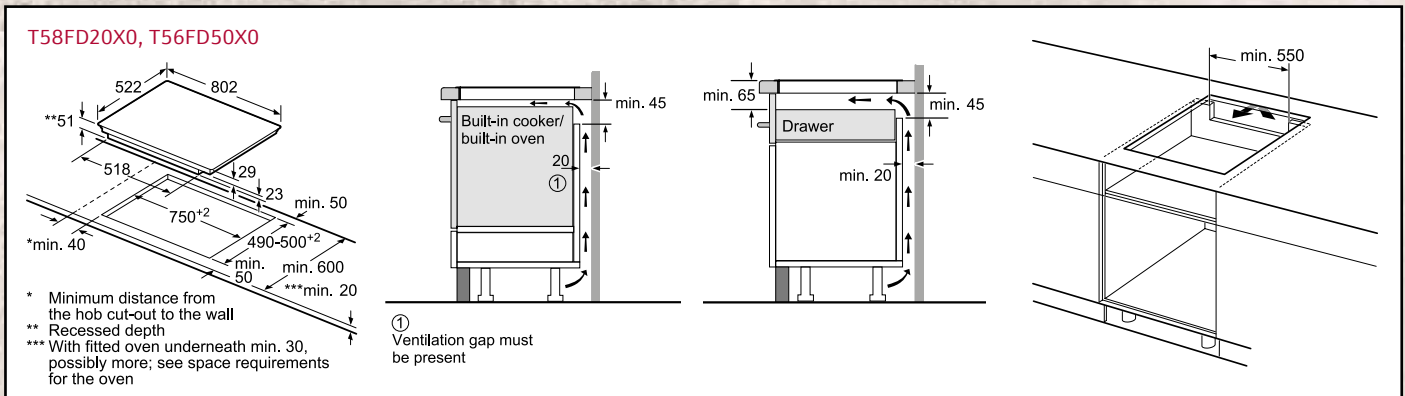

# Induction Hobs

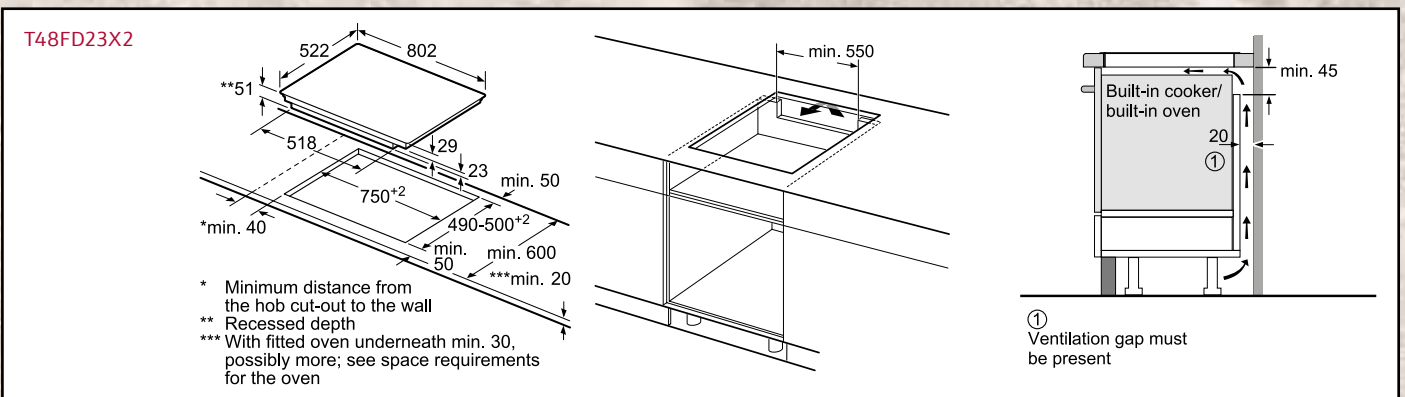
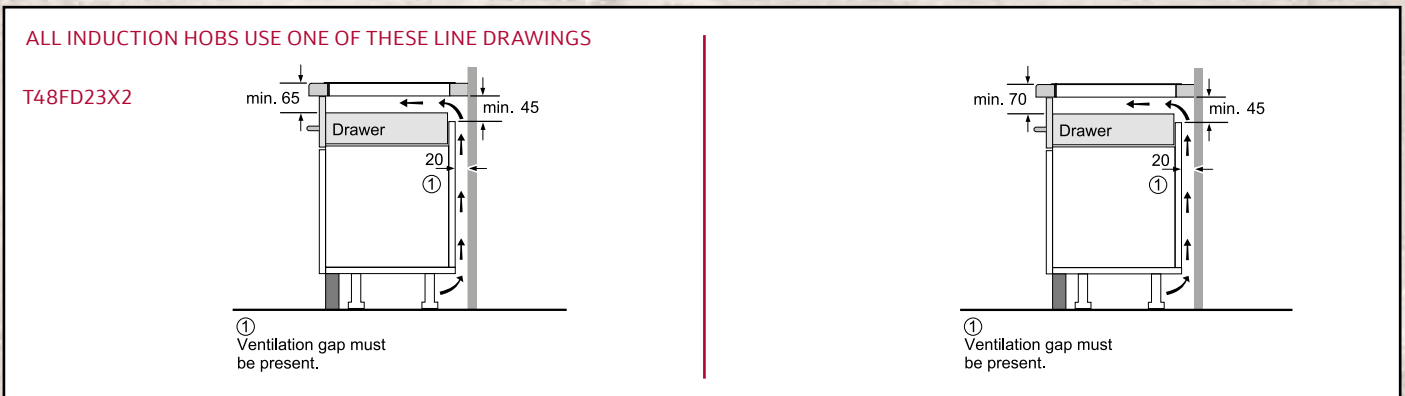

# Venting Hobs

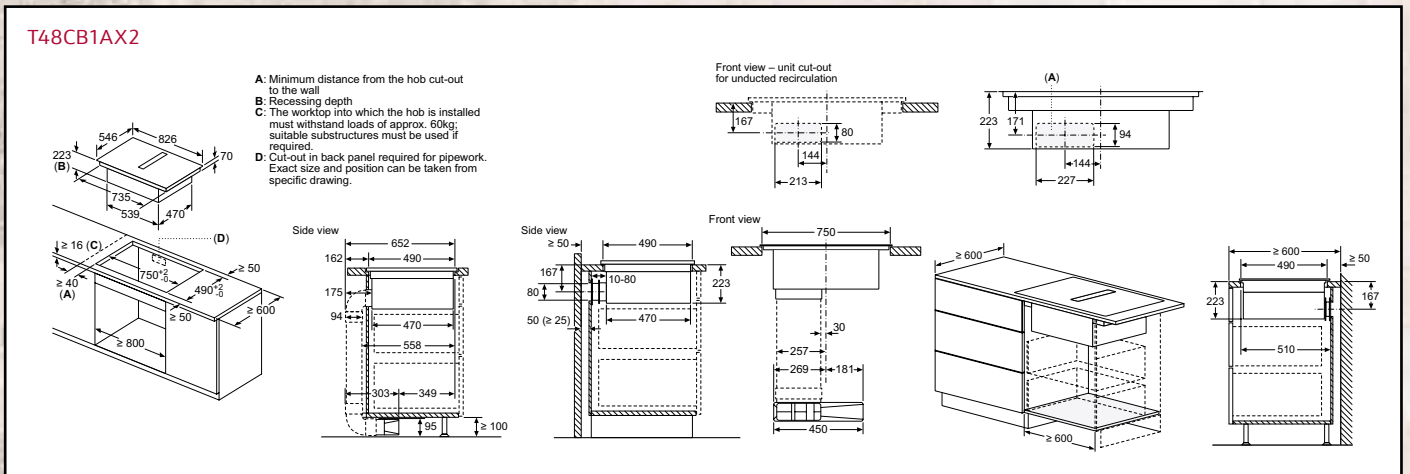

## Venting Hobs Installation Options and Accessories

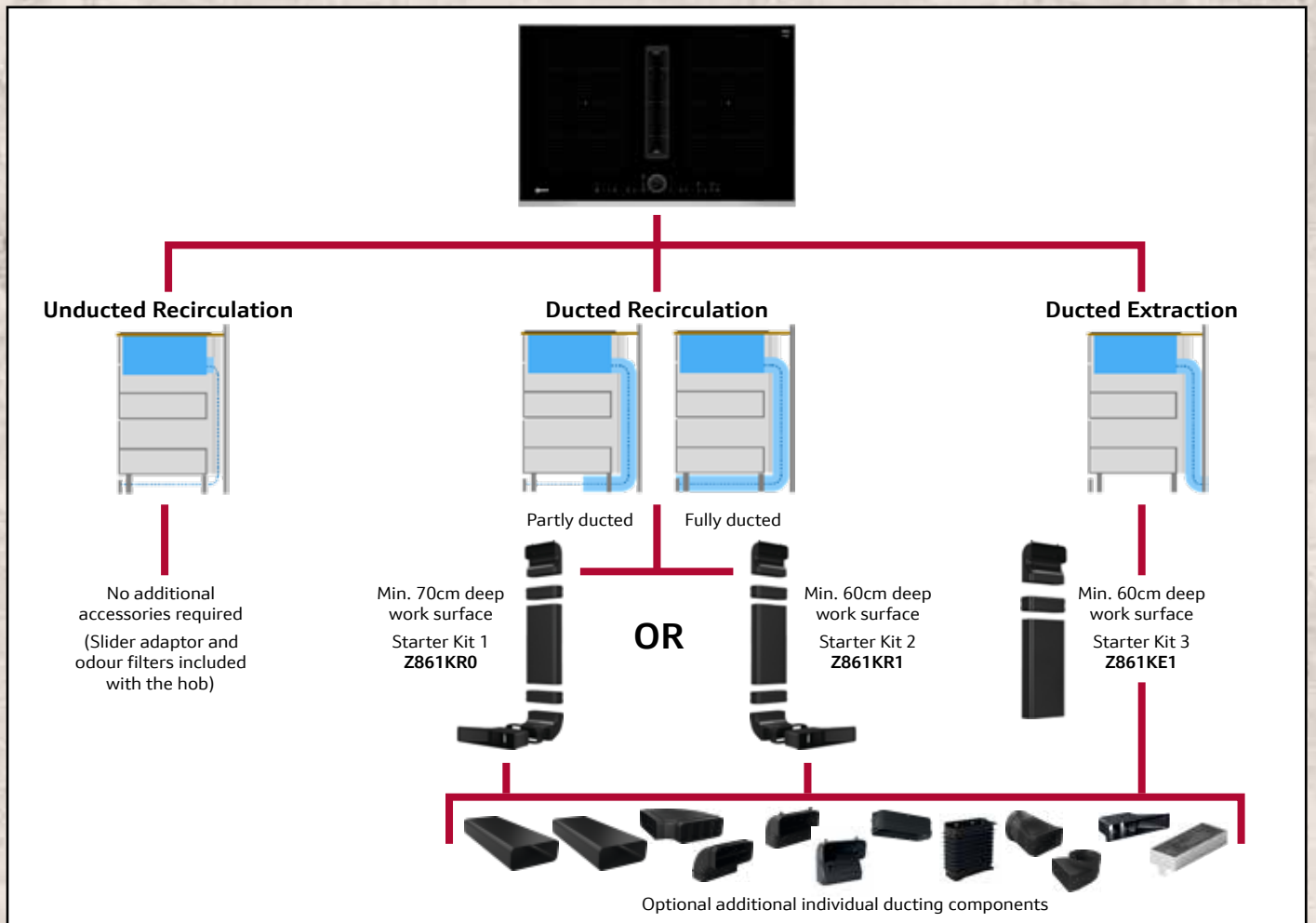



# *Wall mounted solutions.*

Hoods installed on the wall can be used to create a design feature in themselves, adding a focal point to your kitchen while offering powerful extraction for all types of cooking.



# *Open for CREATIVE FREEDOM*

Choose from a range of styles to suit your kitchen design, including the trendy Creative Slim hoods or Angled Glass hoods with features such as Ambient Light that let you express yourself with colour, as well as your cooking.

# Simply EYE-CATCHING

WALL-MOUNTED COOKER HOOD

N 50



**D65IHM1S2B**

- TouchControl: thanks to the integrated flat surface of the control panel, adjustments can be easily made with just one finger
- Intensive speed setting: increases the extraction rate when the steam gets intense
  - LED Lighting – Clear illumination while you cook.
- Reduced Noise: the low-noise motor makes it possible to listen to your own kitchen story





# *Lets keep it fresh*

Fresh, seasonal ingredients are a staple in any NEFF kitchen. That's why the right food storage is so important: all our fridges and freezers - whether it's a large American-style appliance that can cope with the demands of a hungry family, or a built-in model that integrates seamlessly into the kitchen furniture - give you the flexibility to keep your fruit, vegetables and herbs crisp and vibrant for longer.





## Built-In Fridge/Freezer



Designed to fit in a single housing unit, our range of fridge freezers include models from the tall larder style to more compact styles. All of our fridge freezers have a 4 star rating.

## Built-Under Wine Cabinets



Keep wine comfortably stored at the ideal drinking temperature. This ensures the joy of a delicious meal by offering an optimal taste experience through and through – namely by fantastic food and exquisite wine.

## Built-Under Fridge & Freezer



Our integrated fridge with a four star freezer fits neatly under the work surface and provides a compact, flexible cooling solution for busy kitchens.





# *Helping you live the easy life*

Cooking is all about new ideas and fresh inspiration – and our cooling appliances are no different. They are bursting with innovative features and functions to optimally store the food you love.

## **Easy Clean Magnetic Door Seals**

The magnetic door seals on all of our refrigeration range are removable, making them easy to clean and/or replace if necessary.



## **Vario Shelf**

Designed to offer complete flexibility in your fridge, sectioned glass shelves can simply be separated and slid underneath when not in use. Ideal for larger dishes, with space left over for a convenient condiments storage area at the back.

*Create your  
perfect configuration*

## Easy Lift Shelf

With Easy Lift shelving, it's possible to adjust shelves with just one hand – even when they're fully loaded. Perfect when unloading shopping or introducing freshly prepared dishes to the fridge.



## Easy Access Shelf

The retractable glass shelf allows for easy loading and unloading as well as better access to your food. Ideal for putting the finishing touches to those delicate desserts.



## Easy Lift Door Storage

Easily adjust door storage with just one hand. Combined with Easy Lift Shelves, your fridge space won't restrict your favourite foods and drink.



## Bottle Rack

Always have a chilled bottle on standby for those impromptu get-togethers.





# Cooling Range

## WINE CABINET

### N 70 Wine Cooler with Glass door



#### KU9213HG0G

- 82x60 under counter wine cabinet
  - Reversible glass door
  - UV filter protection
    - Dual zone
  - electronic temp display
    - LED light with soft start
- Acoustic door open signal • 44 bottle capacity



## BUILT-IN FRIDGE/FREEZER

### N 30



#### KI7861SF0G

- 177x54 NoFrost bottom freezer
  - XXL MultiBox veg drawer
    - LED light
- Digital temperature control
  - 4 glass shelf
- sliding hinge • 60/40 split,
  - 3 freezer drawers



#### KI7851SF0G

- 177x54 NoFrost bottom freezer,
  - XXL MultiBox veg drawer
    - LED light
- Digital temperature control
  - 3 glass shelf, sliding hinge
    - 50/50 split
- 4 freezer drawers



#### KI5871SF0G

- 177x54 Low Frost bottom Freezer
  - LED
- Digital temperature control
  - FreshSafe
- 4 glass shelves
- sliding hinge
- 70/30 split

Moving to KI7861SE0G in March 2024 - better energy

Moving to KI7851SE0G

BUILT-IN FRIDGE/FREEZER

N 50



**KI1812SF0G**

- 177x54 Built in fridge
  - FreshSafe
  - LED Light
  - 7 Glass shelves
  - Sliding hinge



**GU7212FE0G**

- 82x59.8 Built Under Freezer
  - SuperFreeze
  - 3 drawers
  - Door Open Alarm
  - Fixed hinge
  - Plinth ventilation
    - no frost



BUILT-IN FRIDGE/FREEZER

N 70



**GI7813EF0G**

- 177x55.8 Built in Freezer
  - NoFrost, DayLight
  - 7 compartments
  - 5 freezer drawers
    - 2 flaps
    - fixed hinge

*Helping  
you live the  
easy life*

Moving to better energy rating model  
GI7812EE0G in December 2023



# *Your Guide To Dishwashers*

## **Clean dishes, whatever your wishes**

Choosing the right appliance to complement your kitchen and lifestyle can be challenging. To help you select the perfect kitchen companion, we've introduced easy-to-follow Collections based on product features, technology, design and simplicity. There's a Collection to suit everyone.



## **Full Size Dishwashers**

Designed to be as flexible and accommodating as possible, our full-sized dishwashers have adjustable baskets and racks to hold large or awkward items, as well as a choice of wash cycles, from intensive to delicate.



S187ECX23G N70  
60CM FULLY INTEGRATED  
with Home Connect

# Feature Highlights

- All dishwasher models come with Home Connect
- Water consumption – 60cm width 9.5L/45cm width 8.5L
- 10 year anti-rust warranty
- Noise level 42 -48dB

The models from the collections can include:

SERIES FUNCTIONS		
Product Function	N 50*	N 30*
Flex 2 Baskets	•	-
Flex 1 Baskets	-	•
Flex Cutlery Drawer	•	•
Number of Options	5	5
Timelight / Infolight	•/•	- /•
DoorOpen Assist	•	-
Open Dry	-	-
White EmotionLight	-	-
Zeolith	-	-
Intelligent	-	-
Gap Illumination	•	-
Vario Hinge	•	-

\*The features included in each collection are an overview only. Please ensure you check the product detail for exact features of each model.

## Dishwasher Flexibility

### Flex Baskets

Fitting casserole dishes, large pans, full dinner sets and tall-stem wine glasses into a dishwasher can be a challenge – especially when you're cleaning your most robust cookware alongside delicate items. Our Flex Baskets are designed to accommodate those bulkier items and provide an even, thorough clean. We have two options of basket flexibility to choose from.



#### Flex 1

Two foldable elements in the top and bottom rack provide the freedom to adapt the basket for different loadings.



#### Flex 2

Two foldable flip tines in the top basket and 4 foldable flip tines in the bottom basket offer quick and easy loading flexibility for safe positioning of glasses, cups, pots and pans.



#### Flex Cutlery Drawer

Transform your third loading level into a versatile cutlery drawer. It handily clicks into place whenever you need a tailor-made space for your forks, knives, and small kitchen utensils.



#### Rack-Matic

Allows the top basket to be raised and lowered as needed as well as run on an angle to cater for the wine glasses at the end of the night.



# Key Functions Guide

## Design Features



### AQUA STOP

Protects inlet and outlet hoses from leakage. A safety valve prevents any more water from entering the dishwasher and overflowing – even when the machine is off.



### OPEN DRY

No need to manually open the door of your dishwasher to allow the load to cool off. Open Dry takes care of that by opening the door automatically during the drying phase.



### INFO LIGHT

Info Light projects a red light onto the floor that showcases clearly that this dishwasher is in operation. Info Light is available for fully integrated dishwashers.



### HEAT EXCHANGER

Ensures that the drying phase of programmes is energy efficient and glassware is fully protected by preventing extreme temperatures.



### DOOR OPEN ASSIST

Door Open Assist is the perfect solution for anybody looking to achieve a sleek, handleless design in their kitchen. Simply press lightly on the front of the unit to open the dishwasher door. Ideal for a range of integrated designs, Door Open Assist is also a convenient addition to busy kitchens. Electronic child lock can be activated, creating a double push to open.



### ZEOLITH

A form of mineral, Zeolith has the ability to absorb moisture and turn it in to heat. The heat produced naturally by Zeolith is used during the drying cycle, ensuring that no additional energy is needed to dry your cookware. With the ability to absorb moisture, your glasses will come out steam free and will be cool enough to handle. Automatically activated by programmes with a drying phase, Zeolith regenerates itself and lasts a lifetime, so you don't have to maintain it.



### GAP ILLUMINATION

Gap Illumination shines a soft white light on the side of the dishwasher to indicate the dishwasher is running. If you pause the cycle or open the door, the light will start blinking. This feature is available across Vario Hinge models.



### TIME LIGHT

Time Light projects the remaining time as well as the ongoing process of the programme on any type of kitchen floor. Time Light is available for fully integrated dishwashers and washing machines.



### VARIO HINGE

Vario Hinge attaches your furniture front to the door of the fully integrated dishwasher, regardless of whether it's on the floor or in a high cabinet. Vario Hinge smoothly lifts the furniture front above the plinth and base.



### EMOTION LIGHT

LED lights in the front edge light up the dishwasher cavity.



### GLASS CARE SYSTEM

Your dishwasher has a thing for delicate glassware, so it fine-tunes the water hardness to protect your glassware with never-ending care. A combination of the Glass 40° programme and Extra Shine option will clean your items impeccably without worry. With the introduction of anti-slip surfaces, silicon inserts and supports within Flex 2 baskets your glassware has never been more protected.

## 10-YEAR, ANTI-RUST WARRANTY

Due to advanced materials and manufacturing technologies, in addition to our standard appliance warranty, we're able to provide a free-of-charge warranty against the rusting-through of the dishwasher's inner cavity.

## Programmes



### FAVOURITE

Choose a programme, option, or combination on your dishwasher and save it as “Favourite”, either via your Home Connect app or directly on the dishwasher.



### 1 HOUR 65°

No need to stack your dinner or party dishes for hours, simply load the dishwasher again. This function cleans and dries dishes in only 60 minutes. Spend more quality time with family and friends while enjoying food and tales using your favourite tableware.



### EASY CLEAN

Give your dishwasher a deep clean with the new Easy Clean programme. Simply run the high temperature setting together with some dishwasher cleaner in an empty machine to remove limescale and grease from inside the cavity.



### SILENCE

‘Silence on demand’ whenever you wish for peace and calm select this option via the Home Connect app. On activation the cycle will pause for 30 minutes. You have the flexibility to restart the cycle at anytime if you wish, after 30 minutes the programme will resume.



### AUTOMATIC PROGRAMMES

Take the worry out of selecting exactly the right programme and let the machine do it for you. Automatically changes settings to ensure you get the best clean for your load.



### CHEF 70°C

With a hotter setting and a powerful spray, the Chef 70° programme is perfect for cleaning even the dirtiest pots, pans and cooking utensils. Items placed in the lower basket are subject to higher spray pressures, eliminating the need for soaking and effectively removing even the most stubborn stains.

## Special Functions



### EXTRA SPEED

Depending on the selected programme you can reduce the running time of your dishwasher's programme to up to 66%. Make more of your quality time and enjoy optimum cleaning and drying results - while Extra Speed takes care of the load up to three times faster.



### POWER ZONE

Activates higher wash temperatures and increases spray arm pressure in the bottom basket, while maintaining a more gentle wash in the top basket.



### EXTRA SHINE

By increasing the amount of water during the rinse cycle and extending the drying phase, water marks are prevented and the drying result is further improved.

### EXTRA HYGIENE

Provides a hotter final rinse, with 70°C water for 10 minutes, to effectively cleanse items such as chopping boards and cooking utensils\*.

\*Please note this programme does not sterilise.



# Dishwasher Range – Available now

FULLY INTEGRATED DISHWASHER

N 70

Home Connect



**S187ECX23G**

- 8 programmes
- Flex 2 baskets
- Flex Cutlery Drawer
- 5 options, Open Dry
- TimeLight, Door Open Assist
- White Emotion Light
  - 42dB
  - 9.5L
- 14 place settings

N 30

Home Connect



**S153HCX02G**

- 5 programmes
- Flex 1 baskets
- Flex Cutlery Drawer
  - 5 options
  - InfoLight
    - 48dB
    - 9.5L
- 3/6/9 time delay
- 14 place settings

Home Connect



**S153ITX05G**

- 5 programmes
- Flex 1 baskets
- 5 options
  - InfoLight
    - 48dB
    - 10.5L
- 3/6/9 time delay
- 12 place settings.

*Open for*  
**CREATIVE**  
**FREEDOM**





# Core range

## NEFF N50 OVENS WITH SLIDE & HIDE® DOOR

Collection	Display Size	Oven Description	No of Functions	Colour	Home Connect	Model Code
N 90	LCD Display	Slide & Hide® Single Pyrolytic Ovens	14	Black with Graphite-Grey	YES	B64CS71G0B
N 90	LCD Display	Slide & Hide® Single Pyrolytic Ovens	20	Black with Graphite-Grey	YES	B64VS71G0B
N 70	LCD Display	Slide & Hide® Single Pyrolytic Ovens	14	Black with Graphite-Grey	YES	B54CR71G0B
N 70	LCD Display	Slide & Hide® Single Pyrolytic Ovens	14	Black with Steel-Trim	YES	B54CR71N0B

## NEFF N50 COMPACT OVENS & MICROWAVES

Collection	Display Size	Oven Description	No of Functions	Colour	Home Connect	Model Code
N 90	LCD Display	Compact 45cm Microwave Combination Ovens	20	Black with Graphite-Grey	YES	C24MS31G0B
N 90	LCD Display	Compact 45cm Microwave Combination Ovens	20	Black with Stainless-Steel Trim	YES	C24MR21N0B
N 70	LCD Display	Compact 45cm Microwave Combination Ovens	20	Black with Graphite-Grey	YES	C24MR21G0B

## NEFF DRAWER RANGE

Collection	Drawer Range	Colour	Model Code			
N 70	14cm Warming Drawer	Black with Graphite-Grey Trim	N24HA11G1B			
N 70	14cm Warming Drawer	Black with Stainless-Steel Trim	N24HA11N1B			

## NEFF HOB RANGE

Collection	Drawer Range	Colour	Model Code			
N 70	60 cm Flex Induction Hob	Black Glass	T56FD50X0			
N 70	80cm Induction Hob	Black Glass	T48FD23X2			
N 70	80cm Flex Induction Hob	Black Glass	T58FT20X0			
N 50	80cm Venting Hob	Black Glass	T48CB1AX2			

## NEFF HOOD RANGE

Collection	Hood description	Colour	Model Code			
N 50	Wall-mounted cooker hood	Black	D65IHM1S2B			

## NEFF RANGE BUILT-IN FRIDGE/FREEZER COLLECTION

Collection	Drawer Range	Colour	Model Code
N 70	82X60cm under counter wine cabinet	Glass door with stainless steel bar handle	KU9213HG0G
N 70	177x55.8 Built in Freezer	White	GI7813EF0G
N 50	177x54cm built in fridge	White	KI1812SF0G
N 50	82x59.8cm Built under freezer	White	GU7212FE0G
N 30	177x54cm No Frost bottom freezer	White	KI7861SF0G
N 30	177x54cm No Frost bottom freezer	White	KI7851SE0G
N 30	177x54cm Low Frost bottom freezer	White	KI5871SF0G

## NEFF DISHWASHER RANGE

Collection	Dishwasher description	Colour	Home Connect	Model Code
N 70	60 cm Fully Integrated Dishwasher	Grey	YES	S187ECX23G
N 30	60 cm Fully Integrated Dishwasher	Stainless Steel	YES	S153HCX02G
N 30	60 cm Fully Integrated Dishwasher	Stainless Steel	YES	S153ITX05G